



# BONSMARA BEESTELERSGENOOTSAP VAN SA

Saamgestel deur die Suid-Afrikaanse Stamboek- en Veeverbeteringsvereniging

Stamboom- en Prestasiedata korrek gesertifiseer

Veilingsdatum: 08/09/2010

Data soos op 29/07/2010 10:38:22

## EXPLANATION OF ABBREVIATIONS IN CATALOGUE

## VERDUIDELIKING VAN AFKORTINGS IN KATALOGUS

Birth details	BIRTH	GEBOORTE	Geboorte Besonderhede
Growth traits	GROWTH RATE	GROEIVERMOë	Groei Eienskappe
Efficiency traits	EFFICIENCY	DOELTREFF	Doeltreffendheids eienskappe
Body measurements	MEASURE	MATES	Liggaamsmates
Reproduction traits	REPROD	REPROD	Reproduksie eienskappe
Detail of parents	PARENTS	OUERS	Inligting van ouers

Lot number	Lot	Lot	Lotnommer
Seller	Seller	Verkoper	Verkoper
Identification number	ID	ID	Identifikasienommer
Generation/Section of Herdbook	Gen	Gen	Generasie/Afdeling van kuddeboek
Award received	Aw/Award	Toek	Toekenning ontvang
Phase tested	Phase	Fase	Fase getoets
Contemporaries in test	Cont	Tydg	Tydenote in toets
Weight in kilogram	Wgt	Gew	Gewig in kilogram
Index	Ind	Ind	Indeks
Accuracy of breeding value	Acc	Akk	Akkuraatheid van teelwaarde

BREEDING VALUES		TEELWAARDES	
Birth direct (kg)	Birth Dir	Geb Dir	Geboorte direk (kg)
Birth maternal (kg)	Birth Mat	Geb Mat	Geboorte maternaal (kg)
Wean direct (kg)	Wean Dir	Speen Dir	Speen direk (kg)
Wean maternal (kg)	Wean Mat	Speen Mat	Speen maternaal (kg)
12 Months (kg)	12M	12M	12 Maande (kg)
18 Months (kg)	18M	18M	18 Maande (kg)
Average daily gain (g/day)	ADG	GDT	Gemiddelde daaglikse toename (g/dag)
Mature weight (kg)	Matur Wgt	Volw Gew	Volwasse gewig (kg)
Feed conversion ratio	FCR	VOV	Voeromsetverhouding
Average daily feed intake	DFI	GDI	Gemiddelde daaglikse voer inname
Feedlot profit (Rands and cents)	Feed Prof	Voer Wins	Voerkraalwins (Rande en sente)
Height (mm)	Hgt	Hgt	Hoogte (mm)
Length (mm)	Lgt	Lgt	Lengte (mm)
Calving tempo (calves)	Calf Temp	Kalf Temp	Kalftempo (kalwers)
Scrotal circumference (mm)	SC	SO	Skrotum omvang (mm)

Skin thickness in millimetres	Skin	Vel	Veldikte in millimeter
Length: Height ratio	L:H	L:H	Lengte: Hoogteverhouding
Age at 1st calving in months	AFC (m)	OEK (m)	Ouderdom 1ste kalf in maande
Average Inter-calving period in days	ICP	TKP	Gemiddelde Tussenkalfperiode in dae
Age in years and months	Age	Oud	Ouderdom in jare en maande
Number of calvings	Calv	Kalw	Aantal kalwings
Average Wean index	Ave WI	Gem SI	Gemiddelde Speenindeks
Number of calves	Calf	Kalf	Aantal kalwers
Days open since last calving	Days Open	Dae Oop	Dae oop sedert laaste kalwing
Reproduction index	R.I.	R.I.	Reproduksie Indeks
Calf information	Calf	Kalf	Kalf informasie



# BONSMARA CATTLE BREEDERS' SOCIETY OF SA

Compiled by the South African Stud Book and Livestock Improvement Association

Pedigree- and Performance data certified correct

Auction Date: 08/09/2010  
Data as on 29/07/2010 10:38:22

## BULLS

Lot	Seller	ID	Sec	Phase	BIRTH		GROWTH RATE					EFFICIENCY			MEASURE			REPROD		PARENTS						BREEDER OWN REMARKS	
					Birth Dir	Birth Mat	Wean Dir	Wean Mat	12M	18M	Matur Wgt	ADG	FCR	DFI	Feed Prof	Hgt	Lgt	Skin (mm)	Calf Temp	SC	Sire		Dam				
					Acc	Acc	Acc	Acc	Acc	Acc	Acc	Acc	Acc	Acc	Acc	Acc	Acc	Acc	Acc	ID	ID	AFC (m)	Age	Ave WI	R.I.		
Aw	Cont	Wgt	Date	Wgt	Ind	Ind	Ind	Ind	Ind	Ind	Ind	(mm)	(mm)	L:H	(mm)	Aw	Aw	ICP	Calv	Calv							
1	P.F. SCHEEPERS	CEF 08 0348	SP	D	-1.55 34	0.05 27	2.7 30	-3.8 27	16.6 36	22.7 26	13.0 25	93 34	-301 25	154 25	90.15 32	-21 41	-12 34	14	43.00 35	0.4 39	CEF 060361	CEF 05 0167	30	4	102	101	Versbul
					56	30	02.04.08	204	100	-	-		105	-						356	-	-	512	2	2		
2	P.F. SCHEEPERS	CEF 08 0336	SP	D	-0.99 34	-1.04 27	7.1 30	-4.1 28	26.2 37	34.6 26	14.0 25	121 35	-260 25	354 25	50.28 32	-9 41	5 35	14	57.00 37	0.7 39	CEF 060361	CEF 05 0090	34	4	107	91	Versbul
					56	25	18.03.08	211	107	-	-		104	-						346	-	-	523	2	2		
3	P.F. SCHEEPERS	CEF 08 0319	SP	D	-0.80 34	-0.12 27	7.2 30	0.3 28	22.5 36	29.7 26	8.0 25	29 34	-162 25	-67 25	50.86 32	-22 41	-9 35	14	54.00 35	-7.1 39	CEF 060361	CEF 05 0163	29	4	108	109	Versbul
					56	28	16.03.08	225	114	-	-		97	-						334	-	-	401	2	2		
4	P.F. SCHEEPERS	CEF 08 0368	SP	D	-1.25 35	0.18 28	6.3 31	1.1 28	16.0 37	22.1 28	2.0 27	81 35	-102 26	278 26	28.67 32	-2 41	11 35	14	57.00 41	-2.3 39	CEF 040460	CEF 04 0018	35	5	101	101	Versbul
					56	30	15.04.08	220	101	-	-		93	-						324	-	-	378	3	2		
5	P.F. SCHEEPERS	CEF 08 0433	SP	D	2.26 34	-1.08 28	11.5 31	-3.2 28	22.2 37	27.8 26	10.0 25	150 35	-241 25	470 25	33.57 32	8 41	18 35	16	52.00 10	13.7 39	CEF 05 0450	CEF 04 0161	30	5	100	101	
					13	35	19.08.08	245	100	-	-		116	-						347	-	-	465	3	3		
6	P.F. SCHEEPERS	CEF 08 0649	SP	D	2.06 35	0.20 28	13.8 31	1.4 29	22.4 37	30.6 28	11.0 27	141 35	-184 26	387 26	16.23 33	9 41	18 35	15	56.00 10	19.2 39	CEF 04 0462	CEF 03 0268	27	6	109	108	
					13	38	27.08.08	254	103	-	-		102	-						359	-	-	428	4	4		
7	P.F. SCHEEPERS	CEF 08 0519	SP	D	1.31 35	-0.29 29	12.7 31	2.3 29	28.7 37	36.5 28	16.0 27	182 35	-197 25	609 25	23.15 33	22 42	32 35	15	46.00 10	9.9 40	CEF 04 0462	CEF 00 0042	28	10	106	114	Baie Groei
					13	37	02.10.08	286	111	-	-		121	-						336	-	-	371	8	7		
8	P.F. SCHEEPERS	CEF 08 0530	SP	D	1.93 35	0.05 29	13.5 31	1.1 29	19.0 37	24.9 28	16.0 27	111 35	-54 26	436 26	3.01 33	-3 42	14 35	13	41.00 10	3.1 39	CEF 04 0462	CEF 01 0129	30	8	100	108	
					13	40	19.10.08	275	105	-	-		93	-						336	-	-	399	6	6		

0.06	-0.06	3.1	0.9	9.2	11.6	4.7	53	-61	136	8.4	-4	4		40.1	6.4
------	-------	-----	-----	-----	------	-----	----	-----	-----	-----	----	---	--	------	-----



# BONSMARA CATTLE BREEDERS' SOCIETY OF SA

Compiled by the South African Stud Book and Livestock Improvement Association

Pedigree- and Performance data certified correct

Auction Date: 08/09/2010  
Data as on 29/07/2010 10:38:22

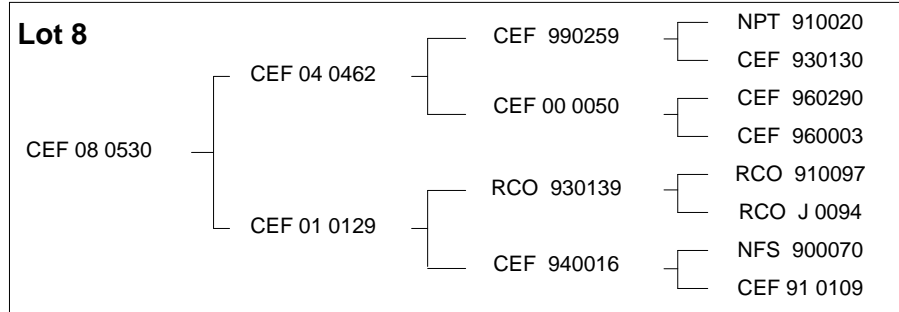
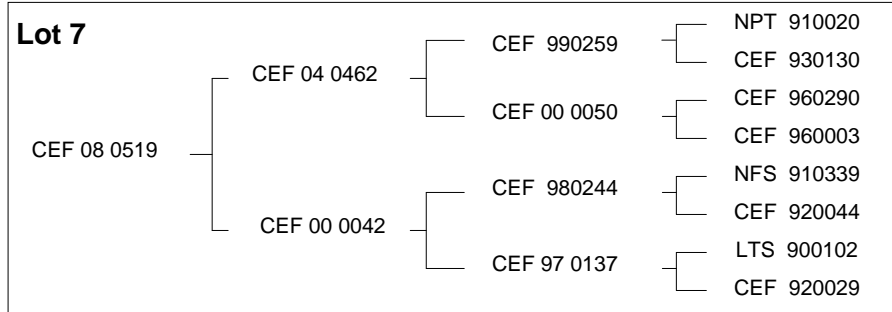
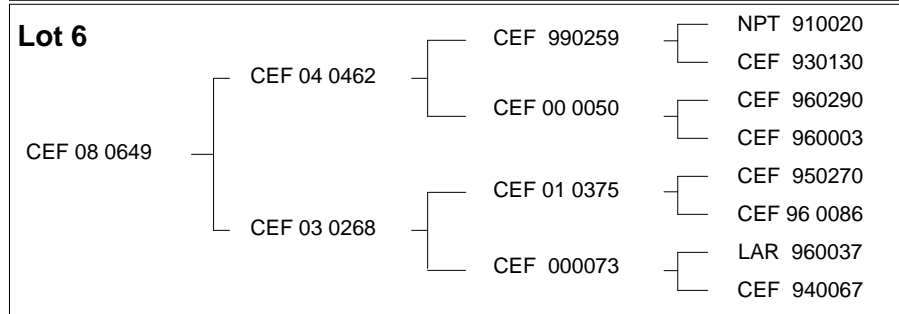
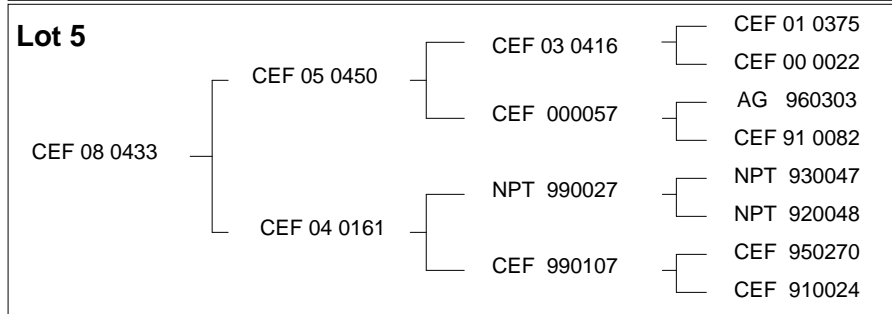
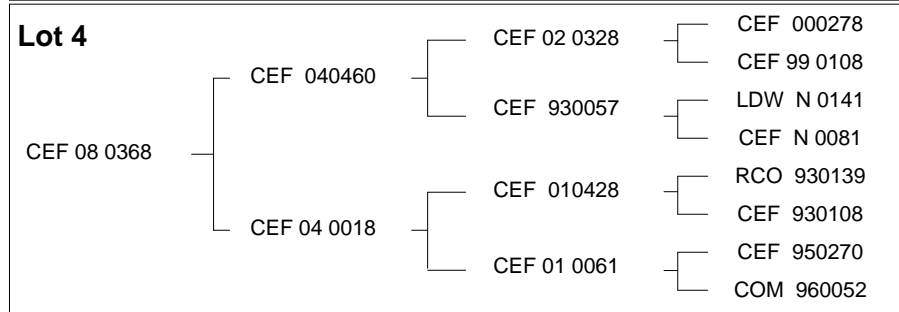
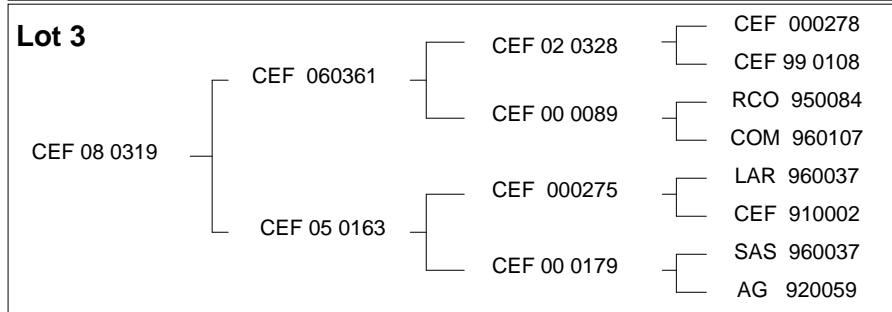
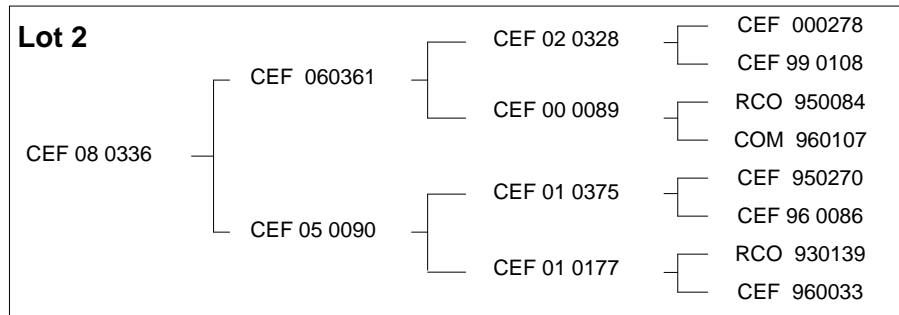
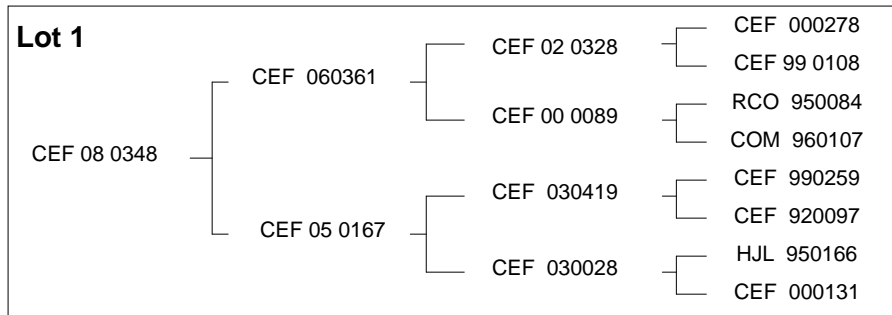



# BONSMARA BEESTELERSGENOOTSKAP VAN SA

Saamgestel deur die Suid-Afrikaanse Stamboek- en Veeverbeteringsvereniging

Stamboom- en Prestasiedata korrek gesertifiseer

Veilingsdatum: 08/09/2010  
Data soos op 29/07/2010 10:38:35

## BULLE

Lot	Verkoper	ID	Afd	Fase	GEBORTE		GROEIVERMOË					DOELTREFF			MATES			REPROD		OUERS						TELER SE EIE OPMERKINGS	
					Geb Dir	Geb Mat	Speen Dir	Speen Mat	12M	18M	Volw Gew	GDT	VOV	GDI	Voer Wins	Hgt	Lgt	Vel (mm)	Kalf Temp	SO	Vaar		Moer				
					Akk	Akk	Akk	Akk	Akk	Akk	Akk	Akk	Akk	Akk	Akk	Akk	Akk	Akk	Akk	Akk	ID	ID	OEK (m)	Oud	Gem SI		R.I.
Toek	Tydg	Gew	Datum	Gew	Ind	Ind	Ind	Ind	Ind	Ind	Ind	Ind	Ind	Ind	Ind	(mm)	(mm)	L:H	(mm)	Toek	Toek	TKP	Kalw	Kalf			
9	P.F. SCHEEPERS	CEF 08 0366	SP	D	-1.44 34	0.68 28	5.5 31	2.2 28	18.7 37	26.5 28	32.0 27	103 35	-183 25	342 25	26.38 32	-16 41	3 35	14	48.00 42	8.9 39	CEF 040460	CEF 04 0195	27	4	106	114	Versbul
				56	30	11.04.08	213	97	-	-		98	-			1123	1364	1.21		348	-	-	379	3	3		
10	P.F. SCHEEPERS	CEF 08 0330	SP	D	0.43 35	-0.29 30	6.8 31	1.3 30	14.1 37	17.6 28	13.0 28	139 36	-234 27	326 27	16.38 33	10 42	19 36	19	51.00 47	11.2 40	VV 04 0046	CEF 03 0088	30	7	107	112	All rounder
				56	35	19.03.08	211	94	-	-		117	-			1193	1391	1.17		345	-	-	368	5	4		
11	P.F. SCHEEPERS	CEF 08 0468	SP	D	1.79 34	-0.96 28	13.9 31	-2.2 28	26.2 37	34.7 27	21.0 26	97 35	-126 25	270 25	6.98 32	2 41	17 35	16	37.00 10	5.8 39	CEF 05 0450	CEF 04 0091	33	4	108	90	
				13	35	08.09.08	279	116	-	-		97	-			1203	1414	1.18		341	-	-	544	2	2		
12	P.F. SCHEEPERS	CEF 08 0477	SP	D	0.24 35	0.45 29	10.0 31	2.6 28	24.4 37	33.0 28	16.0 27	77 35	-113 26	252 26	-3.79 33	-9 42	13 35	16	53.00 10	13.5 39	CEF 04 0462	CEF 02 0114	21	7	104	119	All rounder
				13	37	09.09.08	270	111	-	-		94	-			1184	1424	1.2		358	-	-	383	6	4		
13	P.F. SCHEEPERS	CEF 08 0476	SP	D	2.01 35	0.48 29	13.7 31	3.0 29	33.1 37	42.3 28	27.0 26	151 36	-154 26	478 26	-6.32 33	8 42	19 36	15	50.00 10	25.1 40	CEF 04 0462	CEF 00 0159	30	9	107	109	Baie Groei
				13	40	08.09.08	284	116	-	-		118	-			1223	1424	1.16		370	-	-	394	7	7		
14	P.F. SCHEEPERS	CEF 08 0478	SP	D	0.94 35	0.40 29	10.4 31	1.6 29	20.2 37	27.4 27	22.0 27	94 35	-52 26	270 26	0.52 33	2 42	15 35	15	33.00 10	8.2 40	CEF 04 0462	CEF 00 0192	30	9	104	110	All rounder
				13	38	12.09.08	267	109	-	-		93	-			1205	1416	1.18		341	-	-	387	7	6		



# BONSMARA BEESTELERSGENOOTSAP VAN SA

Saamgestel deur die Suid-Afrikaanse Stamboek- en Veeverbeteringsvereniging

Stamboom- en Prestasiedata korrek gesertifiseer

Veilingsdatum: 08/09/2010  
Data soos op 29/07/2010 10:38:35

